

DESERT BUGGY **XLE**TM

1/5-SCALE READY-TO-RUN

Instruction Manual // Bedienungsanleitung // Manuel d'utilisation // Manuale di Istruzioni



 U.S. Pat. No. 9,320,977

Hardware Zubehör

Visserie et Accessoires Viti e Parti accessori



M3 x 10mm (LOS255005)



3 x 8mm (LOS255002)



M3 x 22mm (LOS255001)

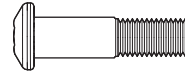

M5 x 20mm (LOS255002)

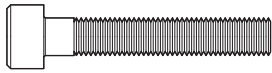

M5 x 30mm (LOS255001)

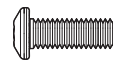

M4 x 12mm (LOS255002)

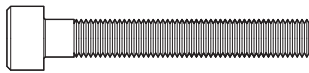

M5 x 35mm (LOS255001)



M4 x 20mm (LOS255002)

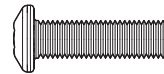

M5 x 18mm (LOS255002)

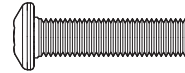

M5 x 20mm (LOS255002)

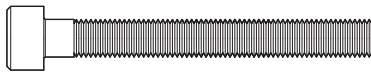

M5 x 45mm (LOS255001)

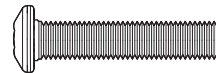

M5 x 24mm (LOS255002)

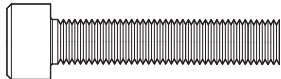

M6 x 30mm (LOS255001)

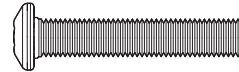

M5 x 28mm (LOS255002)

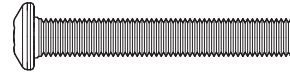

M5 x 35mm (LOS255002)

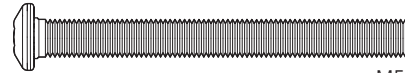

M5 x 50mm (LOS255002)



M2.5 x 10mm (LOS255003)



M3 x 10mm (LOS255003)



M4 x 12mm (LOS255003)

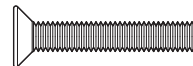

M4 x 22mm (LOS255003)

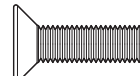

M5 x 14mm (LOS255003)

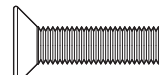

M5 x 20mm (LOS255003)

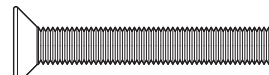

M5 x 32mm (LOS255003)

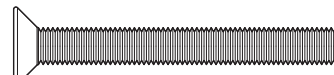

M5 x 40mm (LOS255003)



M4 x 4mm (LOS255000)



M5 x 5mm (LOS255000)



M6 x 5mm (LOS255000)



M6 x 12mm (LOS255000)

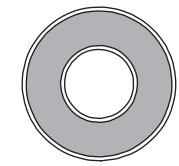

8 x 19 x 6mm (LOS257000)

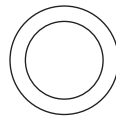

10.1 x 14 x .25mm (LOS256001)

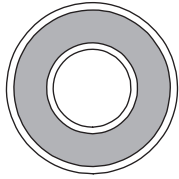

10 x 22 x 6mm (LOS257001)

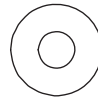

4 x 10 x 1mm (LOS256001)

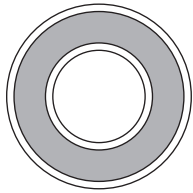

12 x 24 x 6mm (LOS257002)



M4 (LOS256000)



M5 (LOS256000)

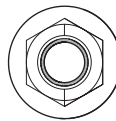

M5 (LOS256000)



7 x 10 x 4mm (LOS257002)

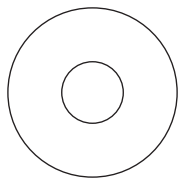

8 x 22 x 0.2mm (LOS256001)



(LOS256005)

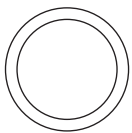

13 x 16 x 0.3mm (LOS256001)

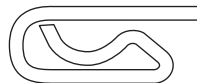

(LOS256005)

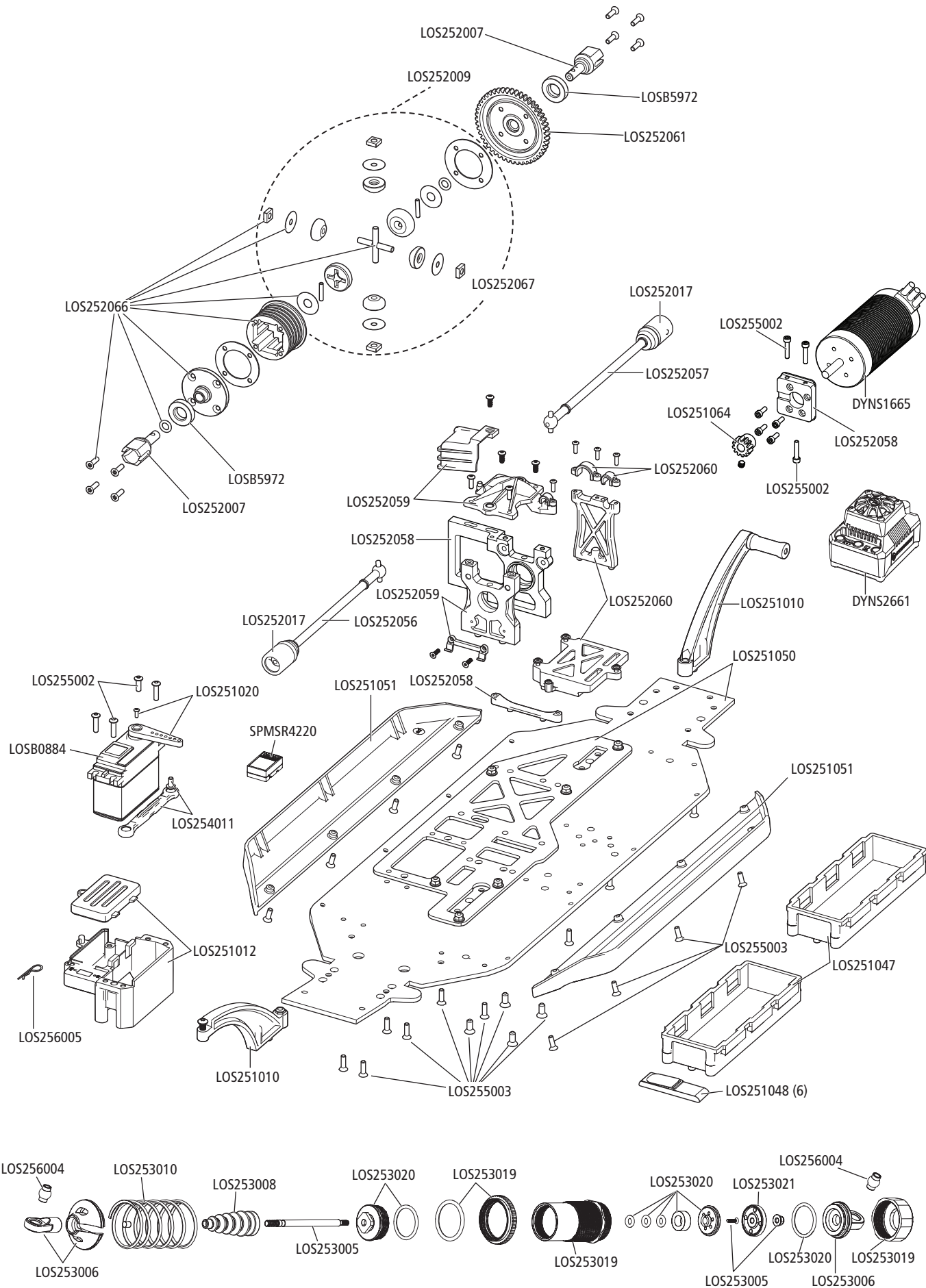

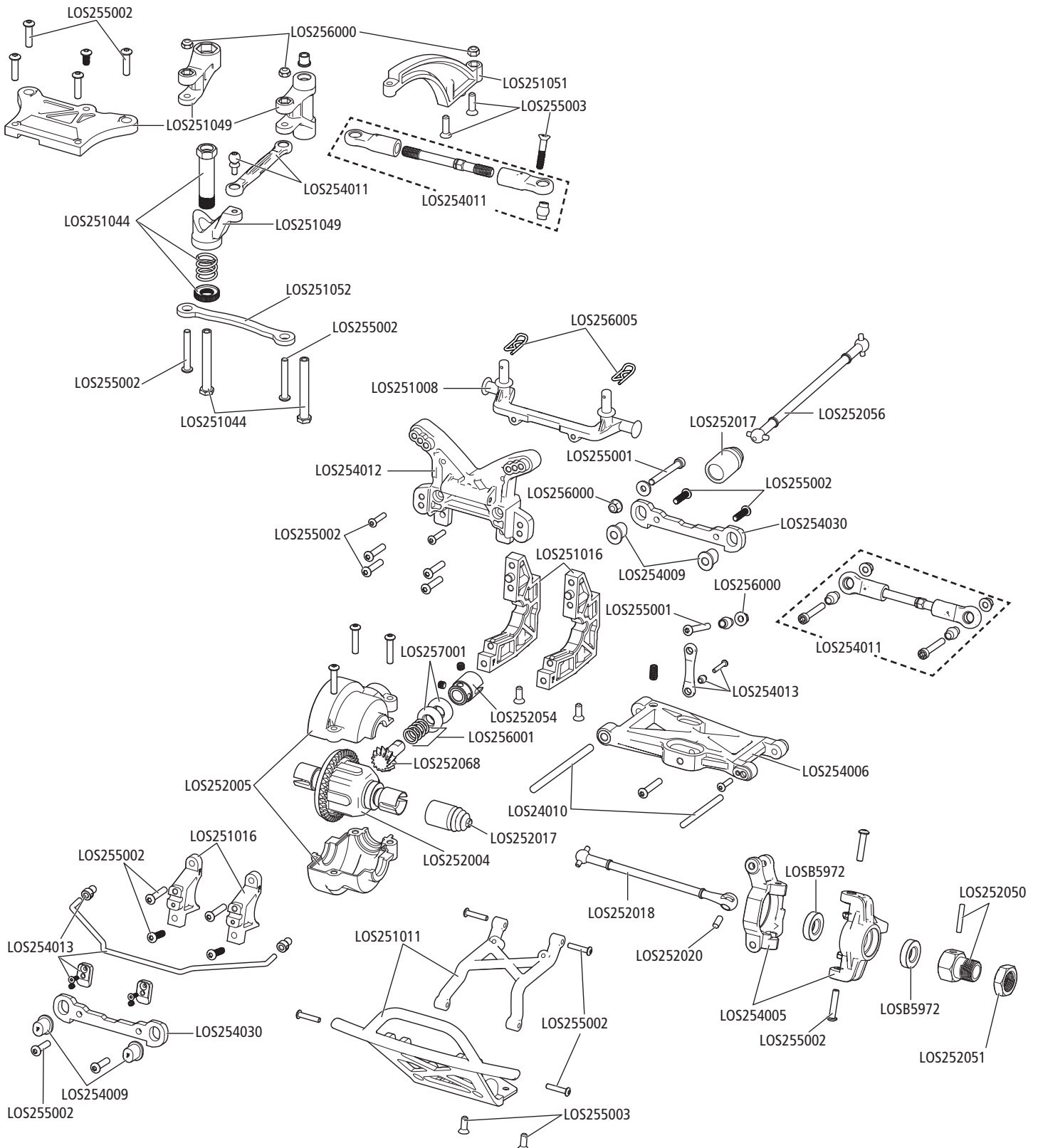
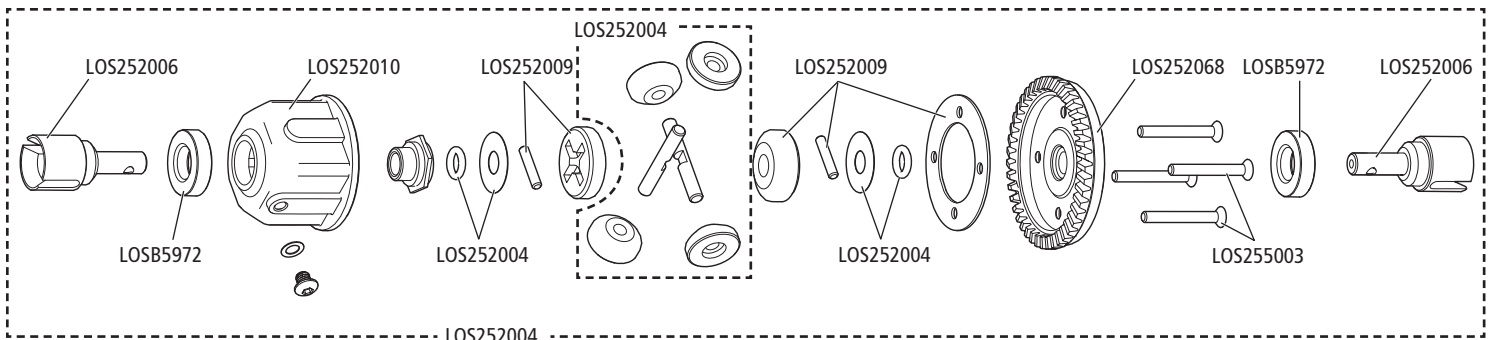

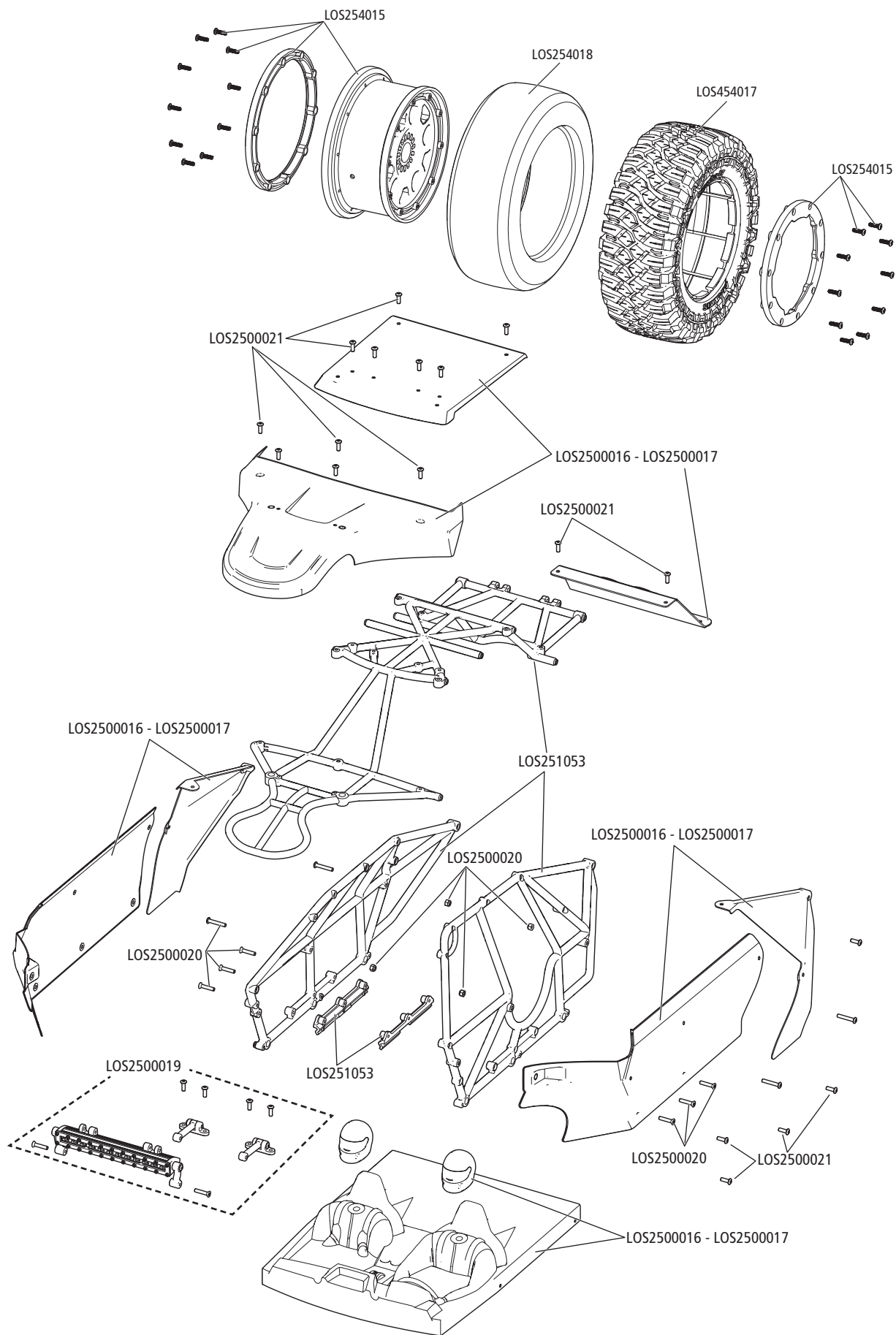



Horizon Hobby, LLC
4105 Fieldstone Road,
Champaign, IL 61822 USA

Horizon Hobby GmbH
Hanskampring 9
D 22885 Barsbüttel, Germany



LOS05012T1 // LOS05012T2

53660

©2017 Horizon Hobby, LLC

Losi, Desert Buggy XL, DSMR, DSM2, DSM, AVC, Active Vehicle Control, EC5, Dynamite, Fuze, Prophet, Passport, Reaction, TLR-Lok and the Horizon Hobby logo are trademarks or registered trademarks of Horizon Hobby, LLC.

The Spektrum trademark is used with permission of Bachmann Industries, Inc. US 9,320,977. Other patents pending.

Created 02/17